

The Billet family has been extended to cover pathway lighting applications. The Billet family of luminaires achieves consistency throughout indoor and outdoor spaces, while maintaining the same optical performance, light consistency, and overall aesthetics for stairs, corridors, and pathways.

The Billet Stealth Step-light was designed to provide lateral and forward throw from a completely concealed light source for minimal glare.

### CONSTRUCTION

**Product Type :** Linear  
**Body Material :** Extruded Aluminum  
**Body Finish :** Black / Grey / White / Custom RAL  
**IP Rating :** IP66

### INSTALLATION

**Environment :** Wet Location  
**Mounting :** Wall Recessed (Trim & Trimless)

### OPTICS

**Optical Distribution :** Pathway - Stealth  
**Glare Control :** UGR<19

### LIGHT SOURCE

**Direct Light Source :** High-power LEDs  
**Luminous Output :** from 325lm/ft. to 1240lm/ft. (Delivered)  
**Light Source CCT :** 2700K / 3000K / 3500K / 4000K / Tunable White (2700K-5000K) / Dim-to-Warm (3000K-1800K)  
**Color Rendering Index :** Ra90

### ELECTRICAL

**Input Voltage :** 120V / UNV 120-277V - 50Hz/60Hz  
**Load :** 2W to 11W  
**Output Type :** Constant Current  
**Driver Type :** Remote  
**Dimming :** 0-10V / DALI / ELV / DMX / Lutron Hi-Lume

Series	Mounting	Nominal Length
<b>BOP</b>	<b>E</b> Wall Recessed with Trim	<b>06</b> 6"
	<b>F</b> Wall Recessed Trimless	
		For exact lengths refer to dimensions table.

Code example: **BOP-F06W-L1H-W-S927-0**

Body Finish	Output <sup>1</sup>	Voltage	Dimming	Baffle	Beam Angle	CRI	Color Temp	Emergency
<b>W</b> White	<b>L</b> 325lm (2W)	<b>1</b> 120V	<b>H</b> No Dimming	<b>W</b> White	<b>S</b> Stealth	<b>9</b> +90	<b>27</b> 2700K	<b>0</b> no
<b>B</b> Black	<b>M</b> 535lm (4.5W)	<b>U<sup>2</sup></b> Universal 120V to 277V	<b>I</b> 0-10V to 1%	<b>B</b> Black	<b>L</b> Stealth with Louvers		<b>30</b> 3000K	<b>9</b> 90 mins
<b>G</b> Grey	<b>H</b> 850lm (7.5W)	<b>2</b> 220V-240V	<b>J</b> 0-10V to Fade-off	<b>S</b> Silver			<b>35</b> 3500K	
<b>X</b> Custom RAL	<b>V</b> 1240lm (11W)		<b>K</b> DALI to 1%	<b>X</b> Custom			<b>40</b> 4000K	
	<b>D</b> 80lm (2W)		<b>L</b> ELV Dimming			<b>WD<sup>4</sup></b> 3000K-1800K		
	<b>W</b> 430lm (11W)		<b>M</b> DMX			<b>TW<sup>5</sup></b> 2700K-5000K		
	<b>U</b> 110lm (2W)		<b>N<sup>3</sup></b> LUTRON					
	<b>A</b> 550lm (11W)							

Notes:

- <sup>1</sup> Denotes output at 3000K, unless otherwise noted.
- <sup>2</sup> Not applicable for ELV dimming.
- <sup>3</sup> Hi-Lume 1% EcoSystem Soft-on, Fade-to-Black dimming.
- <sup>4</sup> Denotes output specific to Dim-to-Warm at 3000K.
- <sup>5</sup> Denotes output specific to Tunable White at full on.

Consult factory for lead-times.  
 Consult factory for systems using multiple optics and mounting configurations.



# OPTICAL FLEXIBILITY

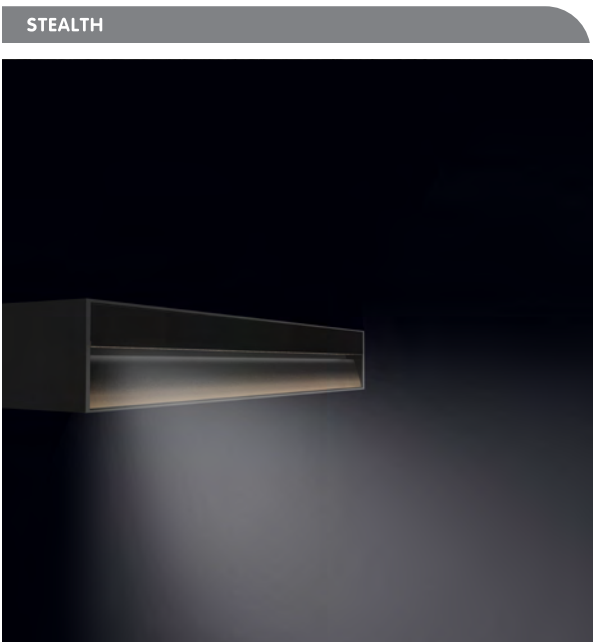

Stealth Reflector

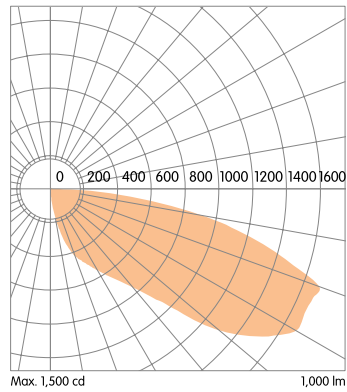

The Stealth Reflector provides even illumination of vertical surfaces with a flexible set back of 1/5 to 1/6 of the wall height and an offset to spacing ratio of 1:1. Stealth's optics are designed to wash large areas where exceptional uniformity and a quiet ceiling is required.

## RECESSED WITH TRIM

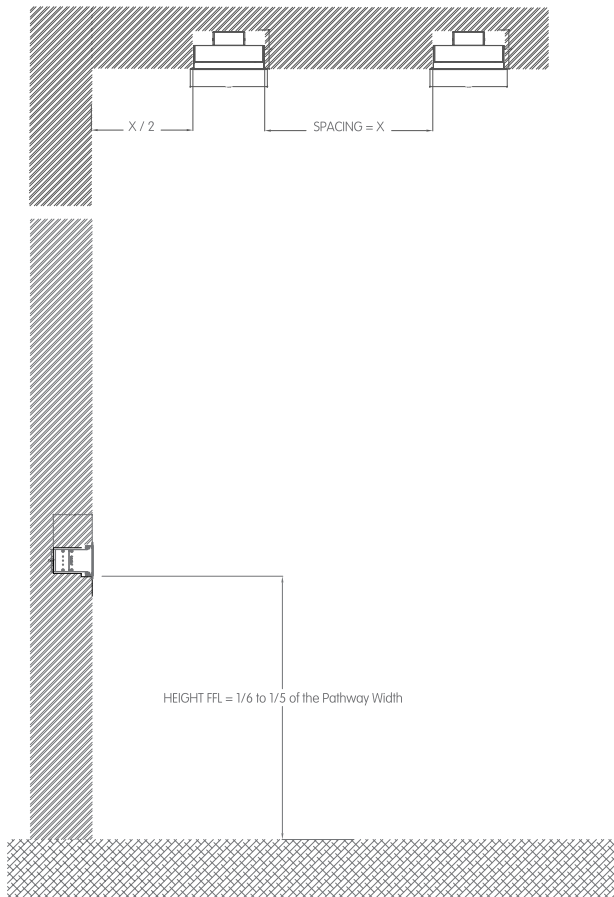

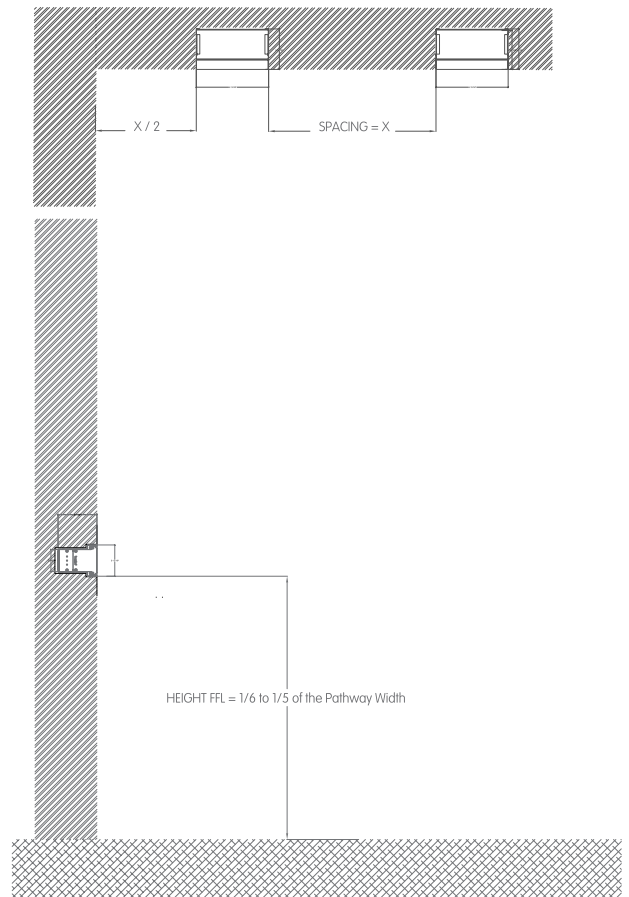

## RECESSED TRIMLESS

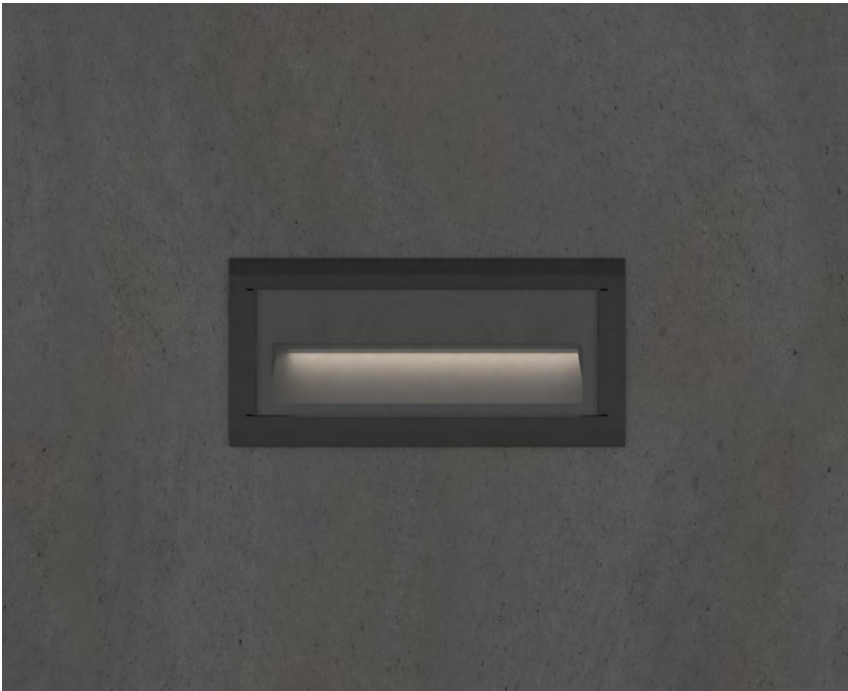

# MOUNTING FLEXIBILITY

## RECESSED WITH TRIM



 (L- $13/16''$  x W- $13/16''$ )

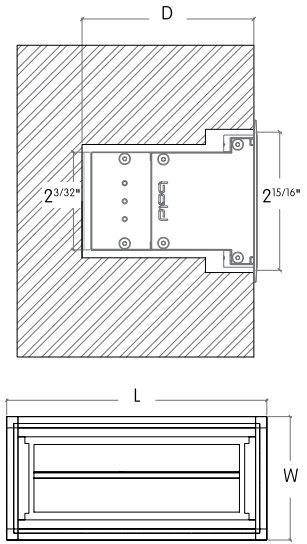

Actual  
L=  $7^{5/16}''$   
W=  $3^{7/16}''$   
D=  $3^{21/32}''$

## RECESSED TRIMLESS



 (L+ $1/16''$  x W+ $1/16''$ )

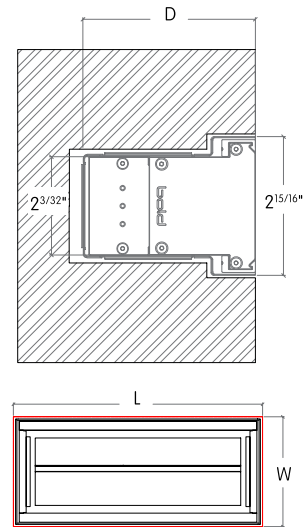

Actual  
L=  $6^{7/8}''$   
W=  $2^{15/16}''$   
D=  $3^{21/32}''$



## DELIVERED LUMEN OUTPUT

Output		Watts				CRI +90			
<b>STATIC-WHITE</b>				<b>2700K</b>	<b>3000K</b>	<b>3500K</b>	<b>4000K</b>		
<b>L</b>	2W			84lm	87lm	89lm	94lm		
<b>M</b>	4.5W			189lm	196lm	200lm	212lm		
<b>H</b>	7.5W			299.5lm	310.5lm	316lm	336.5lm		
<b>V</b>	11W			416lm	432.5lm	439lm	468.5lm		
<b>DIM-TO-WARM 3000K-1800K</b>				<b>3000K</b>					
<b>D</b>	4.5W					230lm			
<b>W</b>	9W					430lm			
<b>TUNABLE WHITE 2700K-5000K</b>				<b>2700K</b>				<b>5000K</b>	
<b>U</b>	6W			240lm				260lm	
<b>A</b>	11W			420lm				450lm	

## DIMENSIONS TABLE

				6"			
		Height		Width		Actual Length	
		mm	inch	mm	inch	mm	inch
<b>Recessed with Trim</b>		91	3 <sup>9</sup> / <sub>16</sub>	88	3 <sup>7</sup> / <sub>16</sub>	185	7 <sup>5</sup> / <sub>16</sub>
<b>Recessed Trimless</b>		93	3 <sup>11</sup> / <sub>16</sub>	75	2 <sup>15</sup> / <sub>16</sub>	175	6 <sup>7</sup> / <sub>8</sub>

